

SPANDICONCIME CENTRIFUGO TRAINATO/SPINTO MOD. COSMINI S/SS

MANUALE D'USO E MANUTENZIONE

📖 Leggere attentamente questo Manuale prima dell'utilizzo della macchina 📖

CENTRIFUGAL PULL/PUSHED TYPE FERTILIZER SPREADER MOD. COSMINI S/SS

USER AND MAINTENANCE MANUAL

📖 Carefully read the manual before using the machine 📖

EPANDEUR D'ENGRAIS CENTRIFUGE TRACTE/POUSSÉ MOD. COSMINI S/SS

MANUEL D'UTILISATION ET D'ENTRETIEN

📖 Lire attentivement ce manuel avant d'utiliser la machine 📖



CE

TRADE MARK



COSMO s.r.l.

Via Laghi d'Avigliana, 117

12022 BUSCA - Cuneo - ITALY

Tel. +39 0171 946654/946655 • Fax +39 0171 946723

www.cosmosrl.com • imcosmo@cosmosrl.com

**PULL TYPE/ HAND PUSHED
CENTRIFUGAL SPREADER
MODEL S 50-70-120**

OWNER'S MANUAL

Read the Operator's manual entirely before using the machine

The Company

STATES UNDER ITS OWN RESPONSIBILITY THAT THE MACHINE

TYPE	PULL TYPE/ HAND PUSHED CENTRIFUGAL SPREADER
MODEL	S 50-70-120
SERIAL NUMBER	
MANUFACTURING YEAR	

is in keeping with the European Union Law:

98/37/CE

(that abrogates and includes the rules 89/392/CEE, 91/368/CEE, 93/44/CEE and 93/68/CEE)

For the machine's adjustment the following normative laws have been used:

EN 1553 – prEN14017

and also the following technical specifications:

ISO 11684

Busca (CN),

Signature

INDEX

1. INTRODUCTION.....	5
2. GENERAL INFORMATION.....	5
2.1. USING THIS MANUAL.....	5
2.2. INFORMATION ON THE MACHINE.....	6
2.2.1. <i>Name plate</i>	6
2.2.2. <i>Characteristics of the machine</i>	6
2.2.3. <i>Terminology</i>	9
2.2.4. <i>Technical data</i>	9
3. IMPORTANT SAFETY INFORMATION.....	10
3.1. SAFETY SIGNALS.....	13
4. PULL TYPE/ HAND PUSHED SPREADER USE.....	14
4.1. Connections.....	14
4.2. Adjustments	15
4.2.1. <i>How to adjust the spreader vanes</i>	15
4.3. HOPPER LOAD.....	16
4.4. SPREADING OF THE FERTILIZER IN THE FIELD.....	16
4.4.1. <i>Spreading mistakes</i>	18
5. GENERAL MAINTENANCE.....	19
5.1. LUBRICATION.....	20
5.2. REPLACEMENT OF THE SPREADER VANES.....	20
5.3. STORAGE.....	21
5.4. SPARE PARTS.....	21
6. WARRANTY	22

COPYRIGHT

The technical information of this manual must be
Considered strictly reserved.
It is forbidden text and illustrations' reproduction.

1. INTRODUCTION

The centrifugal pull type spreaders are machines used for the distribution of solid, granular fertilizers and seeds in the field. They can be used whether with tractors of small/medium power or with ATV-quad.

It is recommended to carefully read this operator's manual of use and maintenance, and follow the recommendations to help ensure safe and efficient operation with and on the machine. This manual has been written, in order to give the customer all the information and safety rules on the machine, as well as use and maintenance instructions that let to make good use of the potentialities of the machine.

The manual must always be handy, so as to consult it, in order to check the operational cycle. If it gets lost or damaged, it will be necessary to ask for a substitutive copy.

In case of some difficulties of interpretation on texts or tables, or if the drawings/sketches are not clear enough, please get immediately in touch with the manufacturer or dealer of the machine for having all the clarifications through the experts in the working/maintenance or through the person who wrote the manual.

We are completely available for a real collaboration in order to improve the understanding of the whole manual.

2. GENERAL INFORMATION

2.1. USING THIS MANUAL

This manual gives all the information for the use and maintenance of the machine. The good working and its life depends on the good maintenance and to the attention during the use. Some pictures in this manual show details or accessories that could be different from those of your machine, some components could be removed, in order to assure the clearness of the pictures.

Some signal words are put on the machine and the operator shall see to keep them in a perfect visual condition, replacing them when they are not readable anymore.

	<p>The symbol on the left, joined to the words under shown: DANGER! ATTENTION! WARNING!</p> <p>Are used in this manual to draw your attention on the safety and good work of the machine. Therefore, it is necessary to observe all the written rules.</p>
---	--

We recommended to use the original spare parts and accessories. The not original parts, besides to decline the guarantee, could be dangerous reducing the length and the performances of the machine.

2.2. INFORMATION ON THE MACHINE

The models introduced in this manual have been designed and made exclusively allowing the distribution of solid, granular fertilizers, salt and sand on walkways as well as seeds in fields. Their use is particularly indicated for the gardening, golf courses, small paths and walkways.

These machines are usually used during the day. If it is required the nocturnal use or with poor visibility, it must use the lighting system of the tractor or of the equipment to which the machine is connected.

A different use, like the above mentioned one is considered improper. Any arbitrary modification made to this machine relieve the manufacturer from any responsibility for damages or lesions, also serious, that can be caused to the operators, to third parties or to things.

2.2.1. Name plate

On the hopper of every machine a name plate is fixed showing the model, the number of series and the year of construction of the machine.

When some spare parts are required, it is always necessary to refer to the type of machine, to the serial number and to the manufacturing year.



2.2.2. Characteristics of the machine

The hardness of the steel welded frame, together with the remarkable life of the plastic hopper, lets to obtain a highest quality level of the pull type spreaders.

The painting is made by an epoxy varnish with successive backing at 150°C with the application of the primer bath, assuring a great protection and long life of the machine.

Vanes

The fertilizer and salt spreader mod. S is equipped with a spreading disc with specular vanes which consent to obtain the maximum precision in both driving directions and in particular a uniform spreading depending on the type of product used.



The feeding of the disc is by gravity through an opening, located on the bottom of the hopper, inside of which a mix/agitator is applied, in order to prevent the fertilizer or salt lumps formation.

A sheet case is placed in front of the disc, in order to prevent the spreading in the front side of the machine.

The dosage of the product occurs by regulating the opening at the hopper's bottom through its regulating lever.

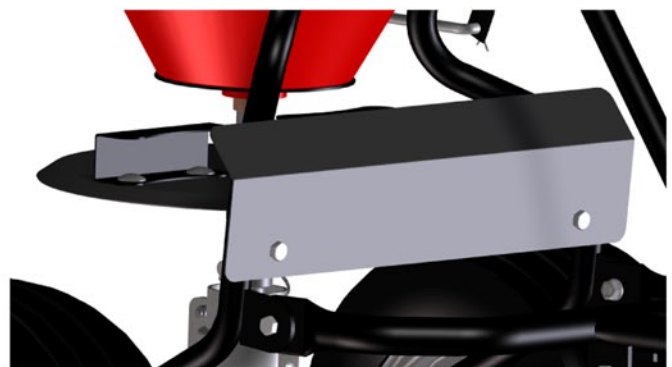

Tongue

The spreader mod. S has a tongue quipped with two brackets in two different positions which consent the double used of the machine, both hand pushed or pull type. At its end there's a hole to fasten either the coupler or the handlebar.



Distributor and agitator are connected through an angle-group with wheels to consent to the distributor disc's rate to be directly proportional to the machine's speed.

In case the machine is used as salt spreader it is necessary to set up a salt limiter on its back side.

It is required to fix its brackets on the frame of the spreader using the bolt and nuts supplied which fasten the hopper to the frame.

Use the knobs to adjust the height of the salt limiter. The lower it is fixed, the shorter is the spreading range and vice versa.

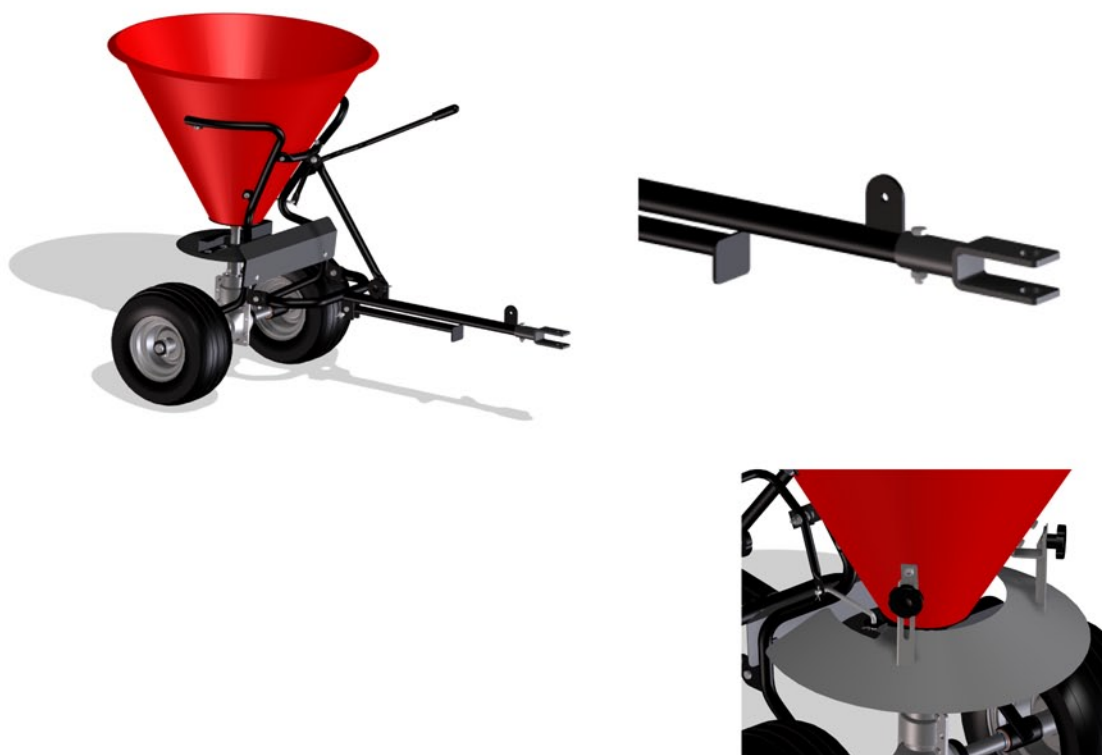

2.2.3. Terminology

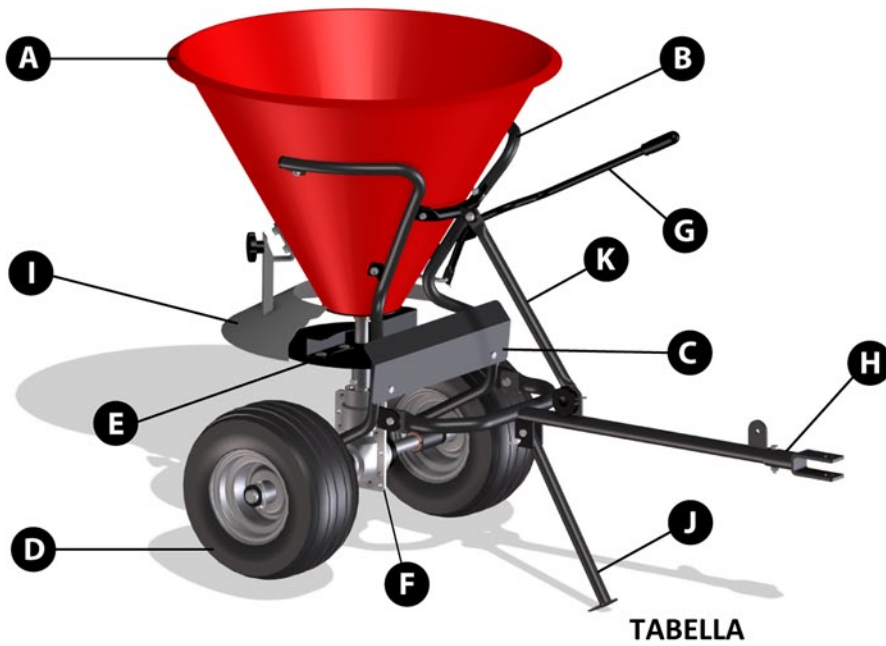

- A. Plastic hopper
- B. Steel frame
- C. Rear
- D. Tyres
- E. Distributor vanes
- F. Gear box
- G. Regulating lever
- H. Rodfor tongue adjustment
- I. Deflector
- J. Tongue
- K. Tongue connection

2.2.4. Technical data

TECNICAL CHARACTERISTICS

Capacity (lbs)	155
Height (inch)	33
Width (inch)	27
Lunghezza (inch)	47
Weight (lbs)	66
Spreading Width(ft)	7/20
Transmission	1:3

3. IMPORTANT SAFETY INFORMATION

THE FOLLOWING SAFETY RECCOMENDATIONS ARE TO SAFEGUARD YOUR INCOLUMITY: THEREFORE IT IS NECESSARY TO READ THEM CAREFULLY, MEMORIZING AND ALWAYS APPLYING THEM.

The present warnings in this manual regard exclusively the allowed uses and reasonably foreseeable. All below instructions must be integrated by the common sense and by the experience of who works, indispensable measures to prevent accidents.

The machine must be used by a single operator. It is forbidden the use of the machine to under-ages.

All the listed instructions must be carefully respected.

Possible changes on the machine not preventively authorized by the manufacturer (by written copy), exclude his responsibility.

Check the correct functioning of the machine, before every employment.

General advices

- Read carefully this manual before proceeding to start, operate, employ or maintenance on the machine.
- Watch, in addition to the warnings of this manual, all the safety , accident prevention rules and of general nature.
- The manual must always be handy , so as to consult it, in order to check the working cycle and safety information. In case of loss or damage, it will be necessary to ask for a substitutive copy.

	<p>ATTENTION!</p> <p>Any work of maintenance, regulation and cleaning must be done with the machine on the ground (in stable conditions), turning off the tractor engine and removing the key.</p>
---	---

- Read carefully the safety signal words applied on the machine and follow the instructions. In case of wear and tear or insufficient readability of the safety signal words, clean them up or replace them, placing the signal words in the right position, as shown in paragraph 3.1.

	<p>ATTENTION! - WARNING!</p> <p>The operator, during the period of use, maintenance, repair, handling or storing of the machine, must wear accident prevention shoes and safety gloves. Moreover, it is necessary that he wears suitable hearing protections such as earmuffs or</p>
---	---

- During loading phase, there is the danger of powders inhalation produced by fertilizer mixing. It is suggested to use tractors with filters on the ventilation system of the cabin, to use suitable safety systems of breathing, like powder masks or masks with filter.

- The machine is designed for being used by a single operator who, during the use, must always stay in the stationing control on tractor.
- Never work with this machine if you are tired, sick or after having took drinks, drugs or medicines.

	<p>DANGER!</p> <p>It is forbidden to climb or to transport somebody when the machine is in motion. Do not let inside the hopper for any reason.</p>
---	--

- Keep the machine cleaned up from foreign bodies (detritus, tools, miscellaneous), as they could damage the operations or the operator. Generally the fertilizers are rather corrosive. For this reason, it is important that any particle of the fertilizer stay in the machine for a long period of time. Clean the hopper and the distributor after each use of the machine.
- If during cleaning operations it is used air or water with pressure, it is necessary to wear glasses and safety masks keeping away possible persons or animals from the machine.
- Before connecting the machine to the tractor or to other self-moving means check that this is in good conditions and that brakes work correctly, especially if you work on sloping grounds.
- Switch off the machine from tractor only on a compact and level ground (with empty hopper), checking that the machine is stable.

	<p>WARNING!</p> <p>During transport operations, stocking and employment of the fertilizers, the operators must follow all the label indications and particularly to the content of the written risks and the precaution suggestions.</p>
---	---

	<p>ATTENTION!</p> <p>The Manufacturer does not answer to possible damages caused by a improper and unforeseen use of the machine.</p>
---	--

The Manufacturer is not responsible in case of:

- improper use of the machine, use by not trained staff;
- serious deficiencies in the foreseen maintenance;
- changes or not allowed interventions;
- use of not original or specific spare parts;
- total or partial inobservance of the instructions;
- inobservance of the common safety rules during work;
- unusual cases.

Operation of the machine

- Make a check of the machine before switching it on. Start to work only if the machine is in perfect conditions.
- Before using the machine, please be sure that all the safety devices are correctly placed and in good state; in case of breakdowns or damages to the protections, please replace them immediately.

	<p>ATTENTION! During work, please be sure that for a radius of 50 meters there are not any person or animals. When you work in proximity of roads or public places, it is ABSOLUTELY OBLIGATORY to keep away persons and to increase the precautions.</p>
---	---

	<p>ATTENTION! Anybody who comes up to the machine is in a danger area, therefore he becomes "AN EXPOSED PERSON". The operator must prevent anybody to come into the danger area and to work with the maximum caution. If somebody comes up, please stop immediately the tractor engine.</p>
---	--

- Before every use of the pull type spreader, please always check the wear of the vanes and of the spreader disc. Check that all the fixing components (screws, bolts etc.) are in and fixed.
- The machine must never be unattended when it is moving.
- Keep always the machine in good operating conditions and make regularly the maintenance.

Transfer on the road

	<p>ATTENTION! Please follow scrupulously the Highway code in force in the country of use. During moves on public roads, it is obligatory to empty the hopper.</p>
---	--

Remember that during moving on public roads, special attention must be done, besides to possible and special regulations noted on the registration book of the tractor, choosing an appropriate speed especially when the street is crowded, winding or sloping. If the pull type spreader hides, with its shape, the back signalling lights of the tractor, it is necessary to put a lights bar and/or some back signalling signs.

Engage the axle with the pin, so that the spreader can be set in action by the turning wheels, only in the moment in which the spreading operation has to be carried out.

3.1. SAFETY SIGNALS

	<p>ATTENTION! Be sure that the safety labels are readable. Clean them up using a cloth, water and soap. Replace the damaged labels placing them in the right position, as subsequently described.</p>
---	--

The safety signs on the machine supply the most important indications: their observance helps your safeness.



	<p>1. ATTENTION! Before making any operation on the machine, stop the engine of the tractor or of the self moving means, remove the key, put on the parking brake and read carefully the operator's manual.</p>
---	--

	<p>2. ATTENTION! - DANGER! Possible throwing of material and/or objects, please do not stop or come up to the machine. Keep a safety distance of 50 meters, at least, from the machine.</p>
--	--

	<p>3. ATTENTION! - DANGER! Forbidden to go inside the hopper or to transport somebody with the machine.</p>
---	--

	<p>4. ATTENTION! Use the Devices of individual Protection required.</p>
---	--

4. PULL TYPE SPREADER USE

	<p>ATTENTION! Before use, please check that gears are adequately greased (see paragraph 5.1).</p>
	<p>ATTENTION! During the use of the machine, please be sure that for a radius of 50 meters there are not any person or animals. If somebody comes up, please stop immediately the tractor engine.</p>

Recommendations for a correct distribution

- Please test always the kg/ha that you wish to spread before starting to work.
- Use a fertilizer or salt in perfect conditions: a humid fertilizer or salt could not be spread uniformly and correctly.
- Avoid to spread the fertilizer or salt during windy days, in order to improve the uniformity of the distribution.

4.1. CONNECTIONS

The pull type spreaders mod. S can be hitched to every type of tractor or ATV-quad.

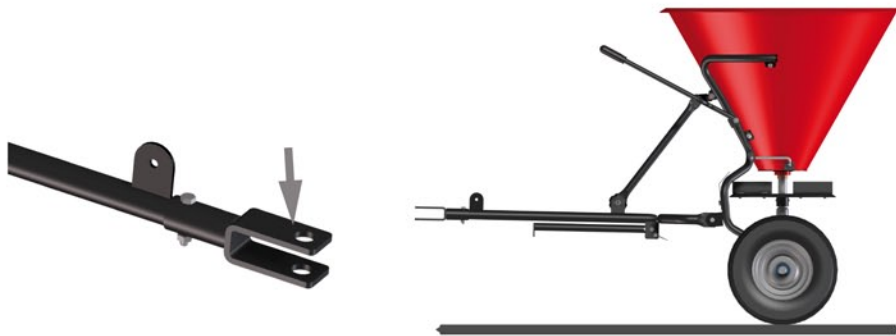

This machine has two travel directions so that it can be both hand-pushed or towed behind quads and vice versa. This change can be made in just two minutes by unscrewing the knob from bracket A (see photo below) and positioning it in bracket B at the extremity of the tongue.

4.2. ADJUSTMENTS

It is not possible to have an exact spreading chart for equipment that make use of the centrifugal principle, as the distributed quantity depends on the speed, on the radius of distribution, on the quality and humidity of the fertilizer or salt and on the roughness of the land.

The fertilizer or salt must always be stored and conserved adequately, so as to keep its physical characteristics unchanged.

It is necessary to set the speed of the pull type spreader, before starting the operation of distribution, trying, in the possible limits, to keep it constant for all its duration.

The spreading charts contain the indicative information, in order to determine the quantity to spread in the field; these must be completed by the experience and competence of the operator.

4.2.1. How to adjust the spreader vanes

The new vanes were developed with specular concept. This means that their lower side reflects the upper side. To invert the spreading direction unscrew the bolts under the disc (see photo below) and reverse the vanes.

Both vanes should be always position in the same direction!



4.3. HOPPER LOAD

It is advised not to carry out the hopper loading manually but using a lifter or suitable mechanical means.

	<p>ATTENTION! The hopper must be loaded only after having hitched the spreader to ATV.</p>
---	---

Do not drive for very long distances with a full load and do not put full bags of the fertilizer loaded in the hopper during the transport to the field or during the working, in order not to overload the capacity of the machine and to compress the fertilizer.

	<p>WARNING! During the operations of transport, stock and use of fertilizers, the operator must be behaved in compliance with the indications on the label of the product and in particular with the content of the sentences of risk and the precaution advices.</p>
---	--

4.4. SPREADING OF THE FERTILIZER IN THE FIELD

	<p>ATTENTION! - WARNING! The operator, during the period of use, maintenance, repair, transport or storing of the machine, must wear accident-prevention shoes and gloves of security. If it is necessary, he will have, moreover, to wear headset,mask and glasses.</p>
---	---

After having hitched the machine to the tractor and having carried out the necessary regulations, it is possible to begin to work.

	<p>ATTENTION! Before getting off from the ATV and before every operation of maintenance and regulation, set in action the parking brake, turn off the engine and remove the ignition key from the dashboard and await the stop of all the moving parts.</p>
---	--



Various ways exist to spread the fertilizer in the field. One of the simplest methods is, as follows:

- Positioning the ATV at the beginning of the field you intend to fertilize, to a distance $(D/2)$ that is the half of the working width that is used (point 1);
- Driving in the field distributing the fertilizer on all the perimeter;
- Stopping the tractor at one distance (D) from the point 1, equivalent to the set working width (point 2);
- Beginning the spreading proceeding in line, straight to point 3;
- Turn the tractor and drive a D distance, equal to the working width (point 4);
- Repeat such procedure until all the plot will be covered.

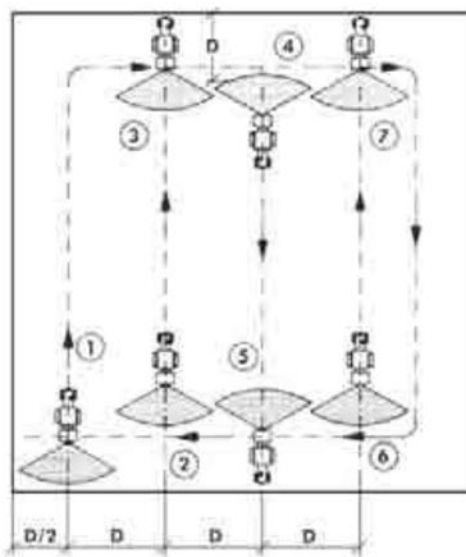

4.4.1. Spreading mistakes

Mistakes of use

- Drive speed;
- Incorrect spreading width;
- The spreading disc is not in a horizontal position compared to the land;
- Drive speed is different to those suggested by the spreading tables, or however not suitable for that particular type of fertilizer;
- Drive mistakes (lack of superimposition of the spreading surfaces);
- Lack of cleaning of distributing discs.

Mistakes due to the fertilizer

- Fertilizer of poor quality.
- Wet or excessive humid fertilizer;
- Incorrect fertilizer composition or it does not correspond to what declared from the vendor;
- Presence of excessive fertilizer lumps or with particular great dimensions that influence negatively on the yield of the spreading;
- Foreign body in the fertilizer.

Mistakes due to the spreader

- Spreading exits clogged;
- Parts of the spreading disc worn away or damaged.

5. GENERAL MAINTENANCE

The ordinary maintenance criteria we suggest, are based on the company experience and on the advices and suggestions from our customers. Such criteria are not exhaustive can be further integrated also with the collaboration of the customers that we thanks in advance. A good ordinary maintenance maintains the operating costs of the machine low and provide an integral exploitation of its potentialities.

	<p>ATTENTION! Whichever work of maintenance, regulation and cleaning must be carried out with the machine on the ground (in stability conditions), engine turned off, handbrake set, key of ignition off and removed from the ignition board.</p>
---	--

In damage case, the operator must stop the machine immediately, assess the entity of the problem and proceed with eventual actions on the machine.

If pressure water or compressed air is used for the cleaning of the machine, it is necessary to protect oneself with proper glasses or protection masks and to remove eventual persons or animals near the machine. Do not use inflammable fluids.

	<p>ATTENTION! For the maintenance operations, always use the fit Individual Protection Devices (accident-prevention footwear and gloves) and to prepare all the accident-prevention steps for the type of operation in course.</p>
---	---

Every 8 hours of effective job, control the tightness of all nuts and bolts.

In case of anomalous vibrations, verify the status of wear of the vanes of the spreading disc, the corrected tightness of all the nuts and bolts and the lubrication of the gear box. The excessive vibration of the machine, besides the specific annoyance, is dangerous and damaging for the entire structure subjecting the mechanical parts to more and more stress cycles compared to the advice pictures.

As regards particular actions that the user does not know or regarding broken parts replacing which are not shown in this manual, it is necessary to consult specialized personnel, making use of the Assistance service by the manufacturer or its distributors.

5.1. LUBRICATION

Before every use and after every 8 hours of effective work, carry out the greasing of the machine.

It is a good use that the greasing nipples are well cleaned up from mud or other residuals before using them for inject lubricating grease.

Lubricate with lithium grease the points, shown in the picture.

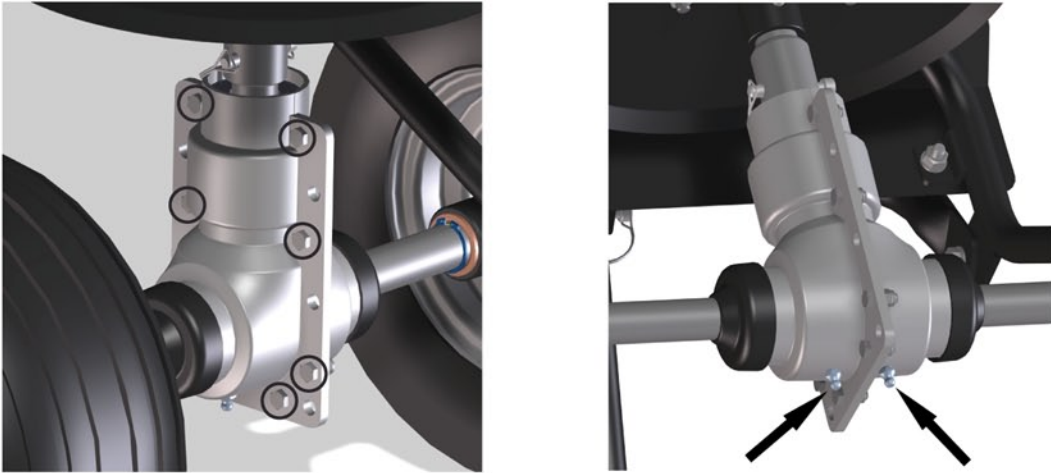

5.2. REPLACEMENT OF THE SPREADER VANES

In case the spreading vanes of the disc brake or get damaged, it is necessary to substitute them with new ones.



Unscrew the nut and replace the damaged vane.

The fixing items (nuts and bolts) must be of the same type of those prescribed from the manufacturer.

5.3. STORAGE

It is a good use not to wait for using the machine to carry out repairing and maintenance.

To repair and to replace the parts that are broken or damaged before the storage, in order to have

always the machine ready for being used. To store the machine in a sheltered place away from atmospheric agents and protect it in order to avoid deteriorations.

The fertilizers are generally corrosive. For this reason it is important that no particles of fertilizer remains on the machine for long period of time.

Before storing the machine for long periods, it is opportune to operate as follows:

- accurately wash the machine and the inside of the hopper;
- to carry out a general control by sight of the machine in order to check eventual structural damages, to find eventual deep abrasions on the paint;
- to verify that the safety pictograms are present in their positions, that they are integral and readable, and in case they are deteriorated or unreadable, carry out immediately their substitution (see par. 3,1);
- to grease all the mechanical parts (to see par. 5,1);
- store, if possible, the machine in a sheltered place.

5.4. SPARE PARTS

For the replacement of parts of the centrifugal spreader mod. S, the customer must use just original parts, ordering them directly to the manufacturer of the machine or to authorized dealers.

Carrying out the order, it is necessary to specify what the identification label brings, in particular:

- serial number;
- model;
- manufacturing year;
- frame registration number.

6. WARRANTY

All the manufactured machines, shown in this manual, are sold with one warranty valid for a year from the delivery date, subject to the following clauses:

- In case a defect in a part is found (or in some parts) during a period of a year from the delivery date of the machine to the customer, the dealer commits himself to verify the defective part and, in case in the course of this verification it is assessed a defect which is due to the materials or to the manufacturing, he will repair the defective part or, to his discretion, to replace it free of charge.
- The customer, at the delivery, must control that the machine has not got damages during the transport, that is in compliance with the one ordered and that is complete with all the accessories got from the purchase contract. In contrary case he must send a written claim within 8 days from the reception of it.
- The warranty is not applied in the following cases:
 - a) normal wear;
 - b) breaches or breaks deriving from negligence or due to the use of the machine in different conditions of the ones permitted;
 - c) in case the machine has got unauthorized modifications (in written document) from the manufacturer or if unoriginal spare parts and accessories were mounted;
 - d) when the serial number of the machine has been modified, removed or cancelled.

In any case the purchaser has to face the wearable parts substitution, the labor, transport costs, the eventual customs costs and the value-added tax. Every responsibility for direct or indirect damages is declined when they are due to breaks or to the wear of the parts, the less for those deriving from the proper or improper use of themselves.

- Defects that are not clearly attributable to the material or to the manufacturing, will be checked by our Technical Attendance Centre or by our warehouse. If the claim would turn out unjustified, all the repair costs and/or substitution of the damaged parts will be debited to the purchaser.
- All the parts will be billed at the shipment time and at the eventual acknowledgment of the guarantees (previous receipt and check of the damaged parts). This will give the right to get the credit.

The manufacturer or its retailer will not be responsible of the loss, neither of the damage, whichever it is and in whichever way it happened during the transport. The aforementioned commitment refers to the person of the customer and it cannot be yielded or be transmitted to others.

9. TAVOLE ESPLOSI

Tavola 01



Tavola 02



POS.	QTY.	COD. ART.	DESCRIZIONE
1	1	302.000	pomolo foro liscio D14
2	1	302.003	pomello leve 8x25
3	3	302.006	spinotto a scatto D7,5
4	2	304.002	cuffia
5	4	304.054	tappo piano D22x1,8-3,5
6	2	304.056	tappo piano D28x0,8-3
7	2	314.002	guscio superiore (scatola riduttore)
8	1	316.012	pignone conico allungato z8
9	1	316.013	corona z26 conica
10	5	325.038	boccola autolubrificante d25 h31 s2,5
11	1	325.060	albero verticale con boccola
12	1	326.003	chiavetta UNI 6604 -A 8x7x20
13	2	329.007	distanziale ferro 25.5x32x7
14	1	329.011	distanziale PVC 65x45x37
15	2	601.050	paletta in Fe
16	1	602.028	tirante apertura cosmini
17	1	604.020	leva regolazione apertura cosmini
18	1	606.177	disco apertura
19	1	609.080	assieme tramoggia cosmini 50 lt fe
20	1	610.151	disco cosmino con boccola
21	1	619.044	agitatore
22	2	620.198	ruota 13x5,00-6
23	1	620.300	albero assale
24	1	620.302	manubrio cosmini
25	1	620.400	telaio
26	1	620.400	telaio
27	1	620.359	raccordo telaio sx-dx
28	1	620.360	telescopico
29	1	620.361	timone
30	1	620.363	pedino
31	1	639.028	carter ferro cosmini
32	1	-	rotary_seal_DIN3760_A_25x52x7
33	1	-	cuscinetto_6205
34	2	-	cuscinetto_6205-2rsr
35	1	-	cuscinetto_6205-2rsm
36	8	-	bolt_DIN603_M8x20
37	2	-	cotter_pin_UNI1336_D2x20
38	2	-	ingrassatore_UNI7663_M8x1
39	5	-	seeger_A_25_DIN471
40	1	-	seeger_RA_19_DIN6799
41	1	-	seeger_A_47_DIN471
42	6	-	shim_washer_PS_25x35x0.50
43	1	-	dado_UNI5448_M8
44	8	-	dado_UNI7473_M6
45	1	-	dado_UNI7473_M8
46	17	-	dado_UNI5588_M8
47	2	-	dado_UNI5588_M10

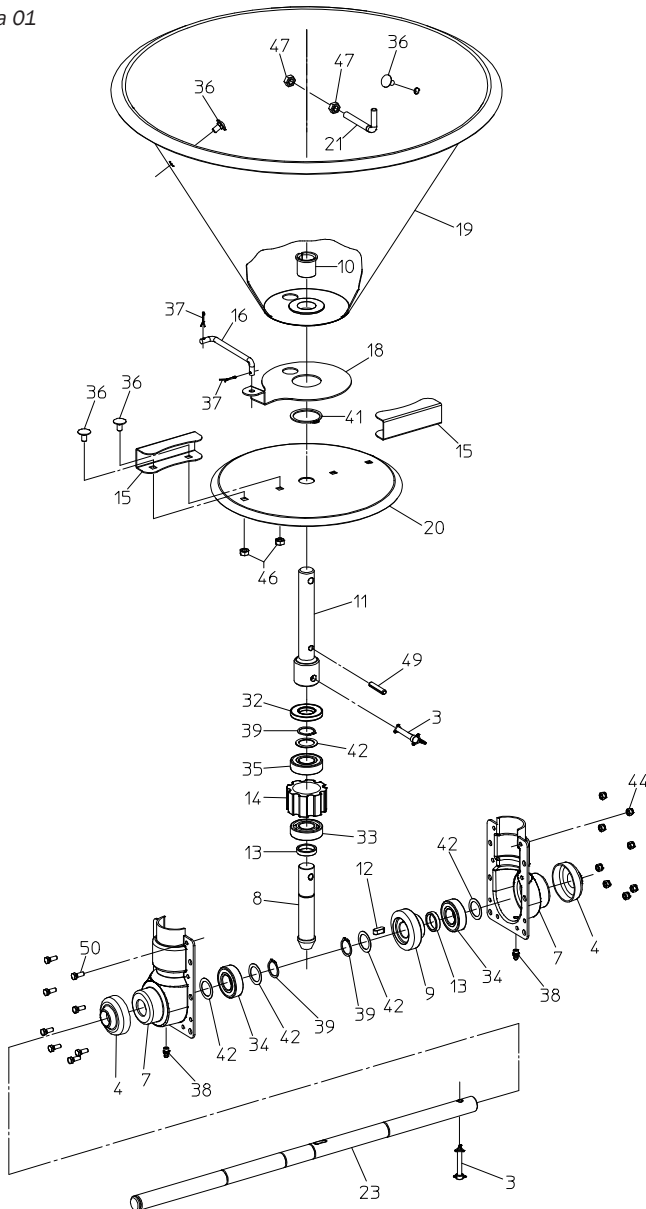
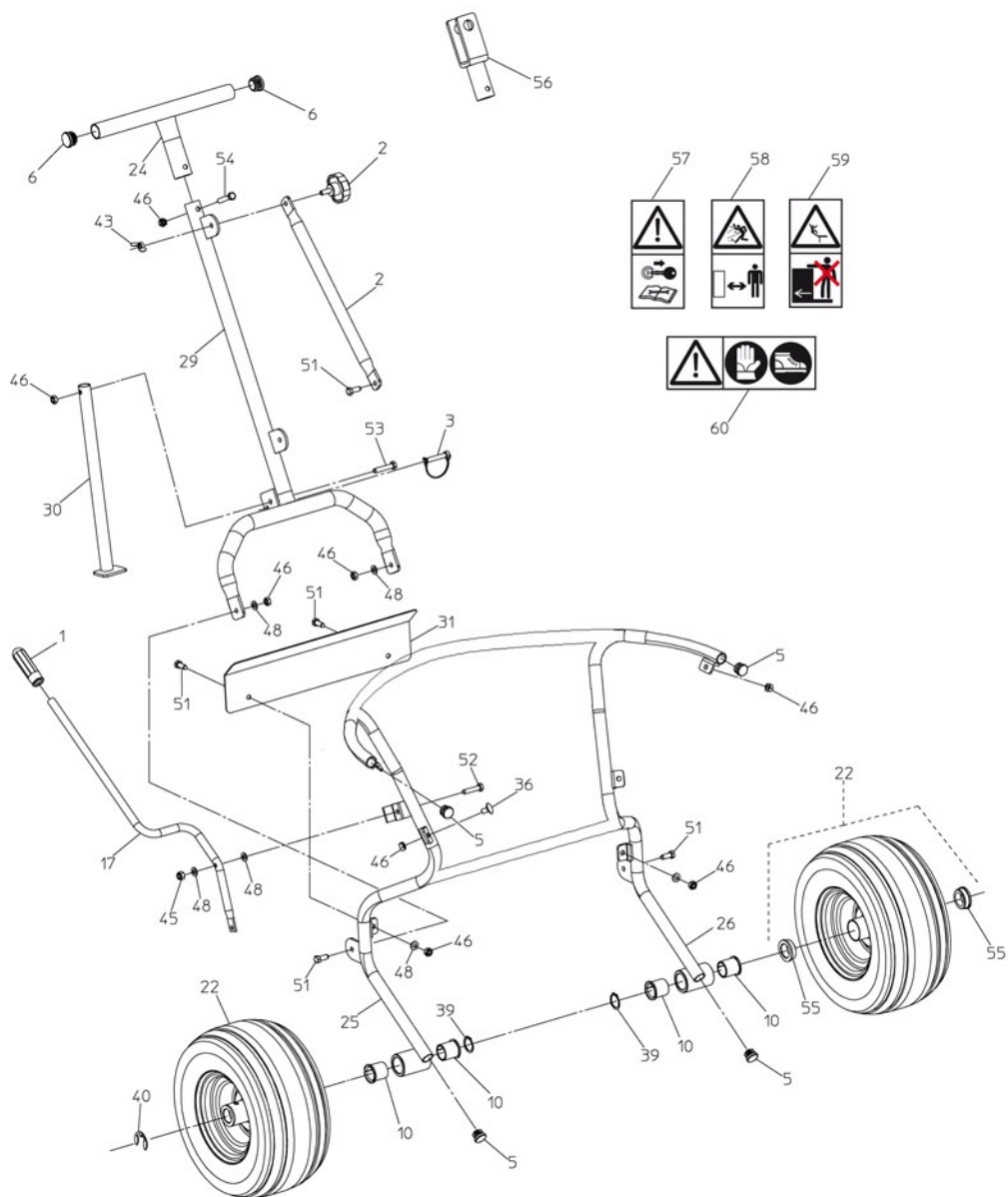